

1 Port RJ-45 Jack Top Entry With 10/100 Base-T Magnetics Module

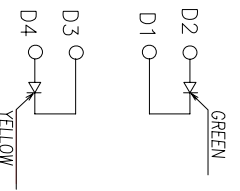

更改 REV	变更内容 MODIFICATION	日期 DATE	制图 DRAW	批准 APPROVE
A	版面发行	2012/10/29	JDL	Oscar

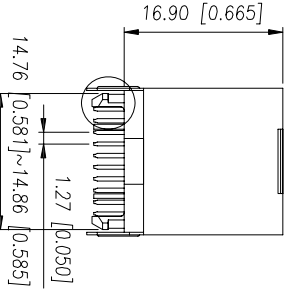
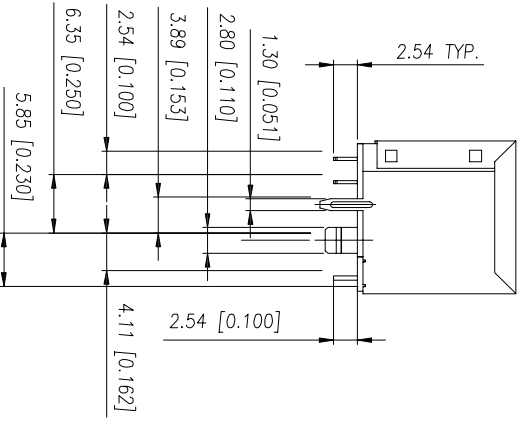
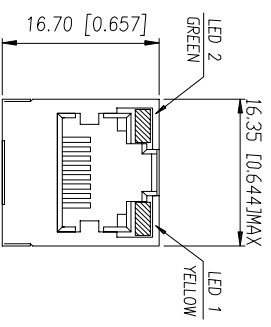

- NOTES:
- MATERIAL:
1. HOUSING MATERIAL :GLASS FILLED POLYESTER(U94V-0);
 2. CONTACT MATERIAL :PHOSPHOR BRONZE T=0.35mm
 3. PLATING :SOLD PLATING OVER NICKEL.
 4. SHIELD: COPPER ALLOY 0.20mm THICKNESS PLATING NI.
 5. LED: OPTION.
- ELECTRICAL:
1. VOLTAGE RATING :125 VAC RMS.
 2. CURRENT RATING :1.5 AMP.
 3. CONTACT RESISTANCE :50 MILLIOHMS MAX.
 4. INSULATION RESISTANCE :500 MEGOHMS MIN @ 500V DC.
 5. DIELECTRIC WITHSTANDING RESISTANCE :1000V AC RMS 50Hz. 1MIN.
 6. LED RATINGS: FORWARD VOLTAGE: 2.2 VOLTS TYPICAL. REVERSE VOLTAGE: 5 VOLTS MAXIMUM.
- MECHANICAL:
1. DURABILITY :750 CYCLES MIN.
 2. PCB RETENTION PRE-SOLDER :1 LB MIN.
- ENVIRONMENTAL:
1. STORAGE : -20°C TO +85°C.
 2. OPERATION : 0°C TO 70°C.
- MATES WITH MODULAR PLUG CONFORMING TO FCC PART 68, SUBPART F.

PART NUMBER: HRJ-YL1B021M1124 VNL-14

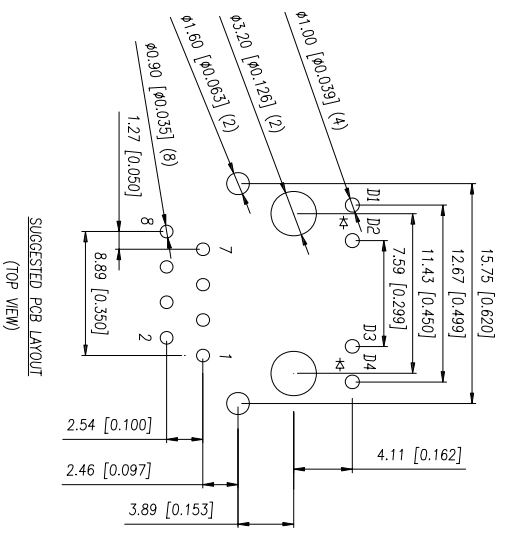
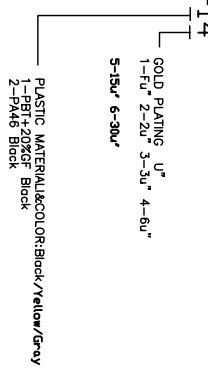

HTTP://WWW.RJ45JACK.COM		YOU LONG CONNECT THE WORLD	
: Cp/Cpk and SPC Control Item		YOU LONG ELECTRONICS LIMITED	
: Inspection Item		文件号 FILE NO. HRJ-YL1B021M1124 VNL	
DIMENSION IN mm [Inch]		图号 DWG NO. HRJ-YL1B021M1124 VNL	
TOLERANCE UNLESS OTHERWISE SPECIFIED		标题 TITLE 10/100Base-T Magnetics Module RJ45 PCB JACK WITH SHIELDED , TOP ENTRY, 1AB-UP, Flat PIN	
.X ± 0.20 X ± 1°		比例 SCALE 1:1	
.XXX ± 0.15 X ± 0.5°		图框 FRAME A3	
.XXXX ± 0.075		审核 CHECK 1	
批准 APPROVE		制图 DRAW Oscar	
检查 CHECK		审核 REV 1	

If you have any questions, Don't hesitate to email sales@rj45jack.com, please!

ELECTRICAL SPECIFICATIONS @ 25°C+/-5°C unless otherwise noted:

Schematics:

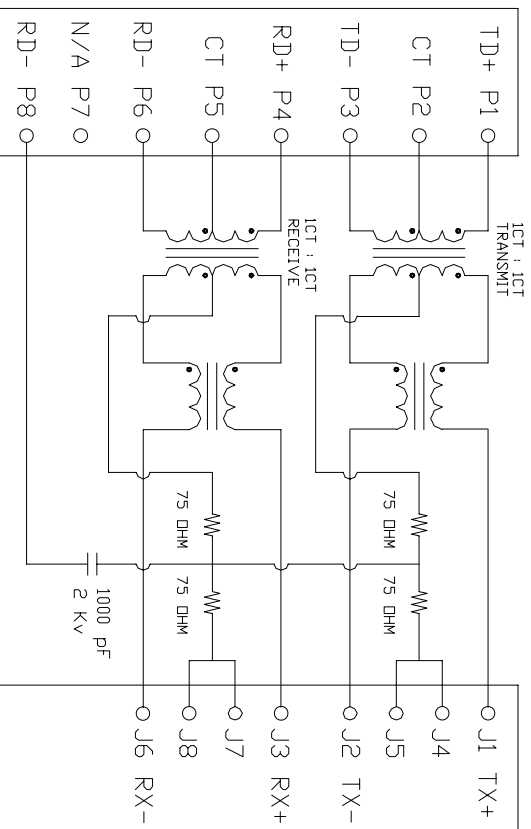

REV	更改内容 MODIFICATION	日期 DATE	制图 DRAW	审核 APPROVE
A	版面发行	2012/10/29	JDL	Oscar

Insertion Loss: 1-100MHZ -1.0dB MAX

**Return Loss: 1-30MHZ -16.0dB MIN
30-60MHZ -14.0dB MIN
60-80MHZ -10.0dB MIN**

**Cross Talk: 1-30MHZ -40.0dB MIN
30-60MHZ -35.0dB MIN
60-80MHZ -30.0dB MIN**

CMR: 1-100MHZ -35.0dB MIN

Hi-Pot: 1500v AC 6S 1mA

OCL:350uH MIN @ 100KHZ 100mV 8mA DC

Turn Ratio: 1CT:1CT+/-3%

Operating temperature range:0°C to +70°C

Housing Material: PBT Black

HTTP://WWW.RJ45JACK.COM

YOU LONG CONNECT THE WORLD

DIMENSION IN mm [Inch]

YOU LONG ELECTRONICS LIMITED

TOLERANCE UNLESS OTHERWISE SPECIFIED

图号
FILE NO. HRJ-YL1B021M1124 VNL

.X± 0.20 X.± 1°

规格
TITLE 10/100Base-T Magnetics Module RJ45 PCB JACK WITH SHIELDED , TDR ENTRY,TAB-UP,Flat PIN

.XXX± 0.15 .X.± 0.5°

图号
PROJ. OSCAR

.XXX± 0.075

图号
SCALE 1:1

QC : Inspection Item

CPK : Cp/Cpk and SPC Control Item

批准
APPROVE

检查
CHECK

审核
Oscar